































		2hp	2.5hp	3hp	4hp	5hp	6hp	รีโมทคอนโทรล
 <p>รุ่นฝังในฝ้าเพดาน กระจายลม4ทิศทาง</p>	PLY	 PLY-P18BAT	 PLY-P24BAT	 PLY-P30BAT	 PLY-P36BAT	 PLY-P42BAT	 PLY-P48BAT	
 <p>รุ่นแขวนใต้ฝ้าเพดาน</p>	PCY	 PCY-P18KALT	 PCY-P24KALT	 PCY-P30KALT	 PCY-P36KALT	 PCY-P42KALT	 PCY-P48KALT	
 <p>รุ่นซ่อนในฝ้าเพดาน แบบDuct</p>	PEY	 PEY-P18JA(L)T	 PEY-P24JA(L)T	 PEY-P30JA(L)T	 PEY-P36JA(L)T	 PEY-P42JA(L)T	 PEY-P48JA(L)T	
<p>ชุดติดตั้งภายนอกอาคาร</p>		 SUY-KA18VA	 SUY-KA24VA	 SUY-KA30VA	 SUY-KA36VA	 PUY-KA42VKA PUY-KA42YKA	 PUY-KA48VKA PUY-KA48YKA	

6

OUTLINES AND DIMENSIONS

PLY-P18BAT.TH
PLY-P36BAT.TH

PLY-P24BAT.TH
PLY-P42BAT.TH

PLY-P30BAT.TH
PLY-P48BAT.TH

Unit: mm

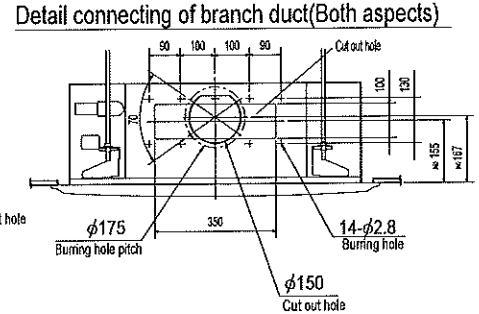
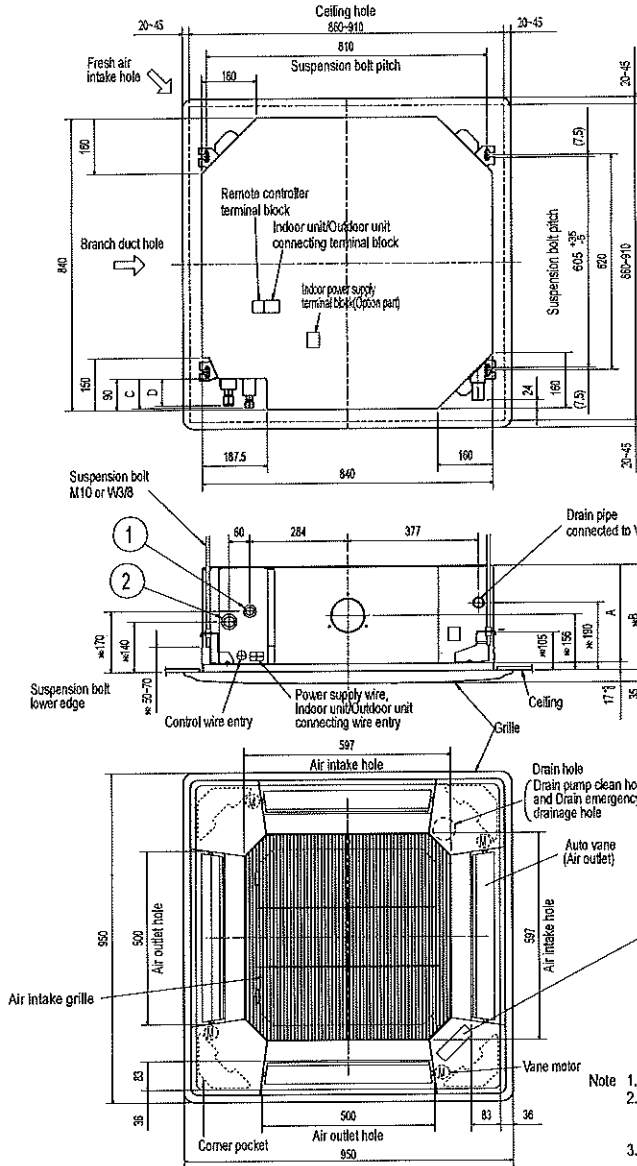

Detail drawing of fresh air intake hole

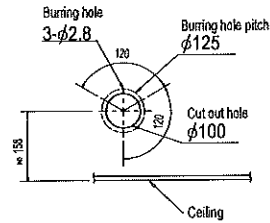

(Connect the attached drain socket)
Keep approximately 10 to 15mm space between unit ceiling and ceiling slab.

In case of standard grille: PLP-6BA-T/PLP-6BAMD-T

In case of auto-grille: PLP-6BA-J

In case of wireless remote controller: PLP-6BALCM-T

Emergency operation switch <Cooling> and Emergency Up/Down switch <Up>
Emergency operation switch <Fan mode> and Emergency Up/Down switch <Down>

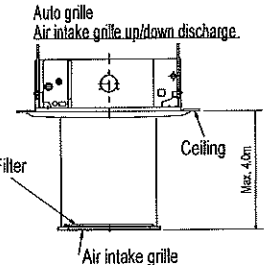
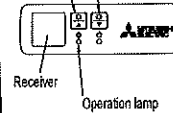

- Note
- Please choose the grille between a standard grille and an auto-grille.
 - As for drain pipe, please use VP-25 (O.D. ϕ 32 PVC TUBE). Drain pump is included.
Max. lifting height is 850mm from the ceiling.
 - As for suspension bolt, please use M10 or V3/8. (Procured at local site)
 - Electrical box may be removed for the service purpose. Make sure to slack the electrical wire a bit for control power wires connection.
 - The height of the indoor unit is able to be adjusted with the grille attached.
 - For the installation of the optional high efficiency filter or optional multi-functional casement.
 - Requires 5 or more space between transom and ceiling for the installation.
 - Add 135 mm to the dimensions * marked on the figure.
 - The optional high efficiency filter must be used jointly with the optional multi-functional casement.
 - When installing the branch ducts, be sure to insulate adequately. Otherwise condensation and dripping may occur. (It becomes the cause of dew drops/water dew.)
 - As for necessary installation/service space, please refer to the left figure.

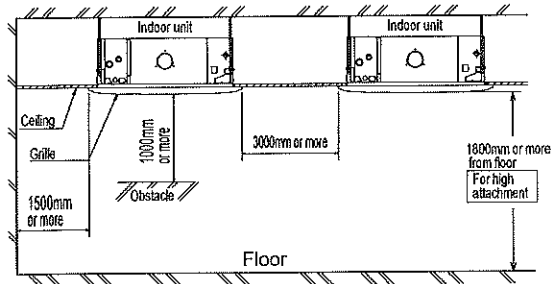

Models	①	②	A	B	C	D	E
PLY-P18BAT.TH	Refrigerant pipe --- ϕ 6.35 Flared connection ---1/4 F	Refrigerant pipe --- ϕ 12.7 Flared connection ---1/2 F			80	74	
PLY-P24BAT.TH			241	258			400
PLY-P30BAT.TH PLY-P36BAT.TH PLY-P42BAT.TH PLY-P48BAT.TH	Refrigerant pipe --- ϕ 9.52 Flared connection ---3/8 F	Refrigerant pipe --- ϕ 15.88 Flared connection ---5/8 F			85	77	440

PCY-P18KALT.TH

Unit: mm

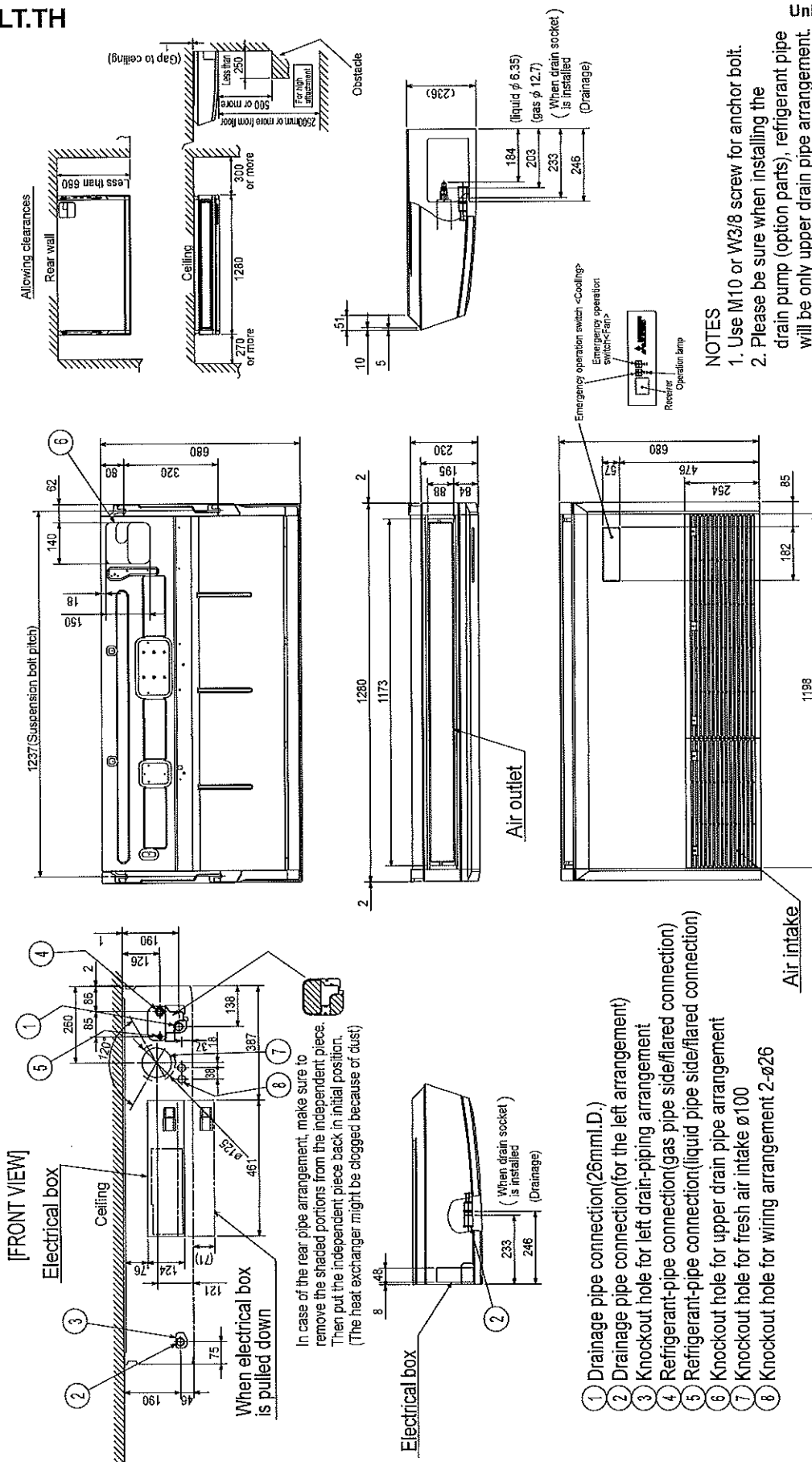

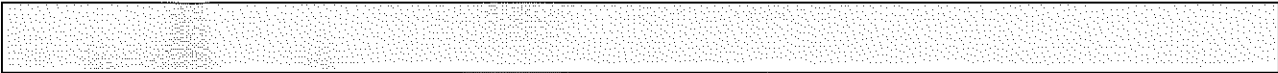

PCY-P24KALT.TH
 PCY-P30KALT.TH
 PCY-P36KALT.TH
 PCY-P42KALT.TH
 PCY-P48KALT.TH

Unit: mm

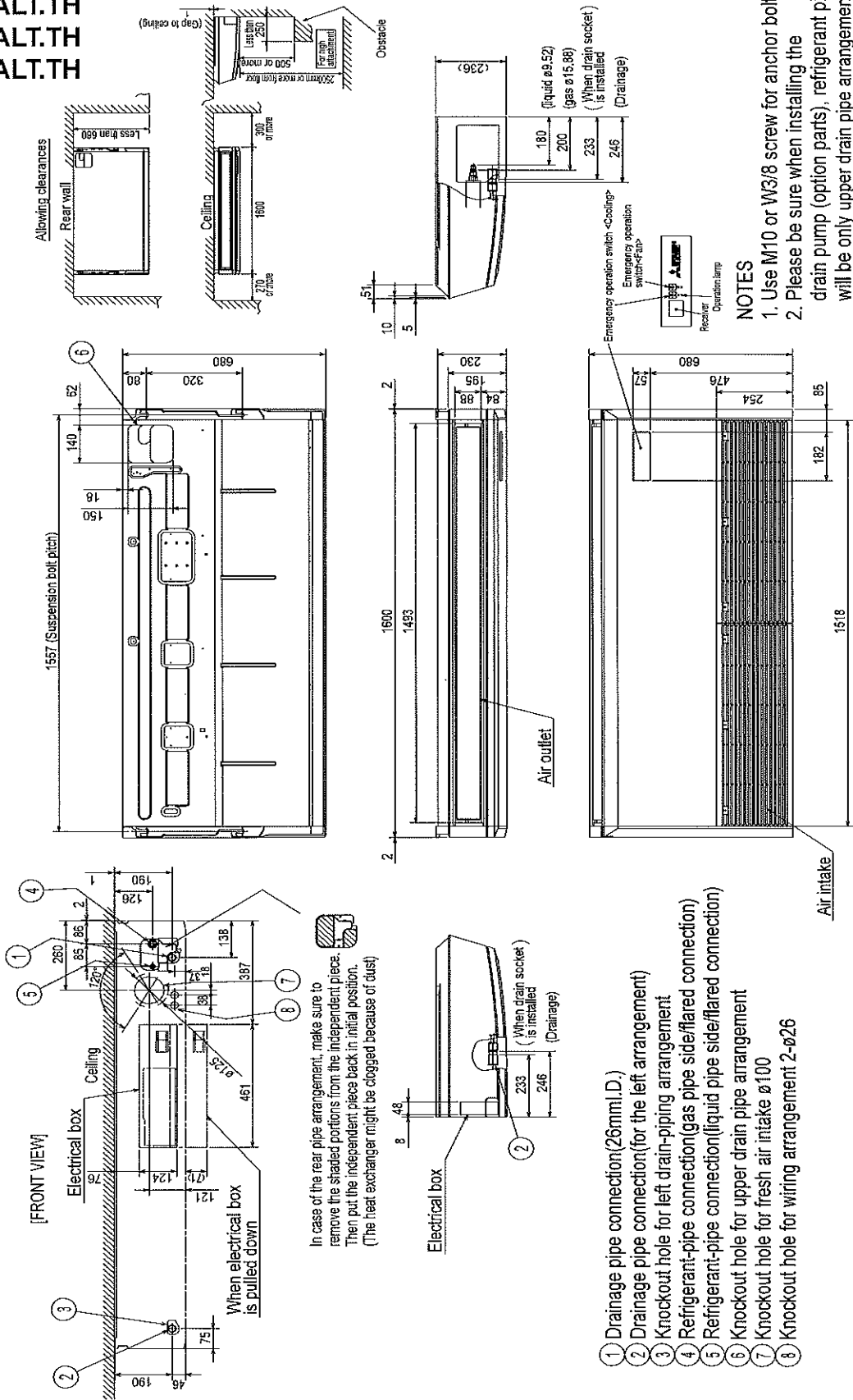

NOTES

1. Use M10 or W3/8 screw for anchor bolt.
2. Please be sure when installing the drain pump (option parts), refrigerant pipe will be only upper drain pipe arrangement.

- ① Drainage pipe connection(26mm I.D.)
- ② Drainage pipe connection(for the left arrangement)
- ③ Knockout hole for left drain-piping arrangement
- ④ Refrigerant-pipe connection(gas pipe side/flared connection)
- ⑤ Refrigerant-pipe connection(liquid pipe side/flared connection)
- ⑥ Knockout hole for upper drain pipe arrangement
- ⑦ Knockout hole for fresh air intake $\phi 100$
- ⑧ Knockout hole for wiring arrangement 2- $\phi 26$

PEY-P18JA(L)T
PEY-P30JA(L)T

PEY-P24JA(L)T
PEY-P36JA(L)T

Unit: mm

- Note 1. Use M10 screw for the suspension bolt (field supply).
 2. Keep the service space for the maintenance at the bottom.
 3. This chart indicates for PEY-P24, 30, 36JA models, which have 2 fans. PEY-P18JA models have 1 fan.
 4. In case of the inlet duct is used, remove the air filter (supply with the unit), then install the filter (field supply) at suction side.

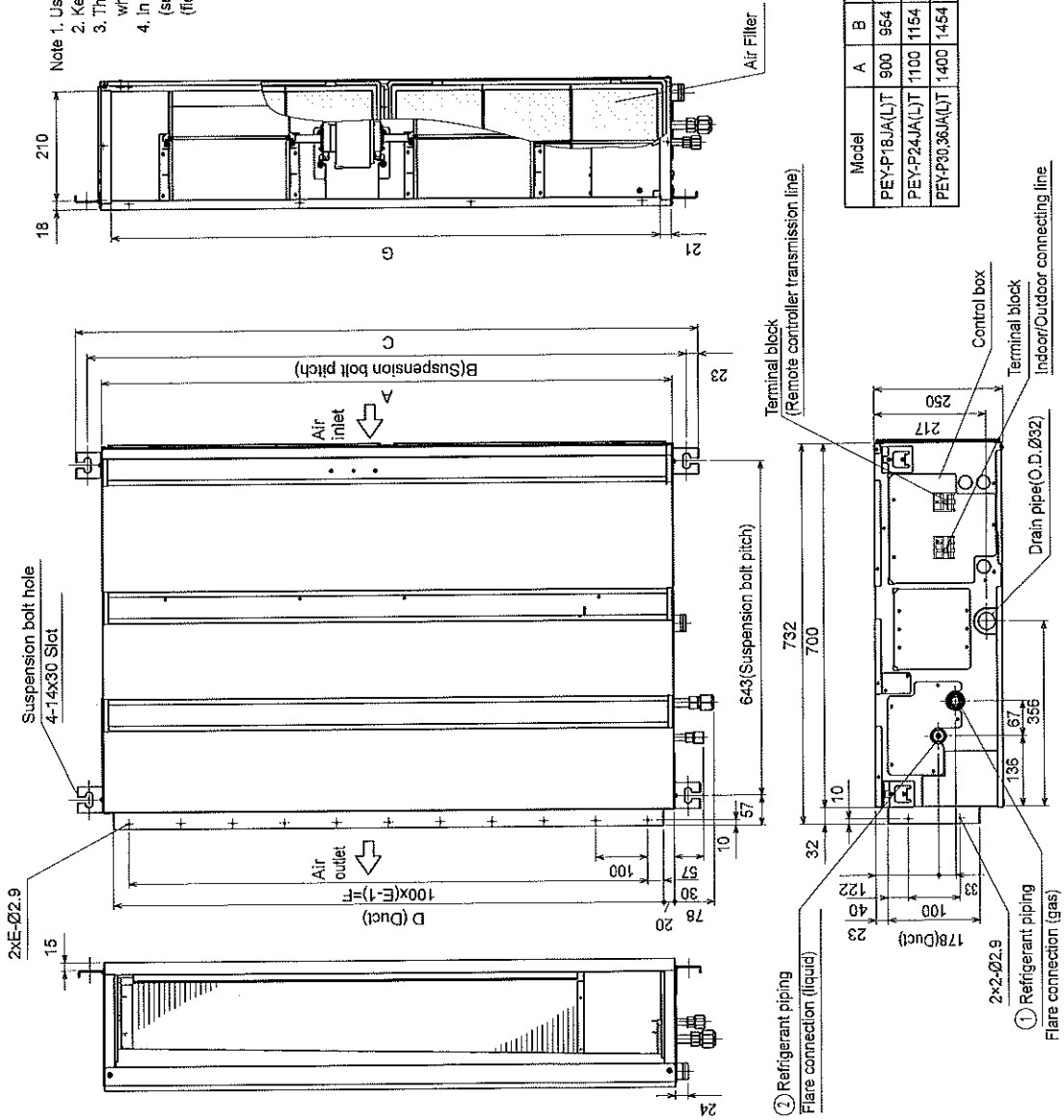

PEY-P42JA(L)T

PEY-P48JA(L)T

Unit: mm

- Note 1. Use M10 screw for the suspension bolt (field supply).
 2. Keep the service space for the maintenance at the bottom.
 3. This chart indicates for PEY-P24, 30, 36JA models, which have 2 fans. PEY-P18JA models have 1 fan.
 4. In case of the inlet duct is used, remove the air filter (supply with the unit), then install the filter (field supply) at suction side.

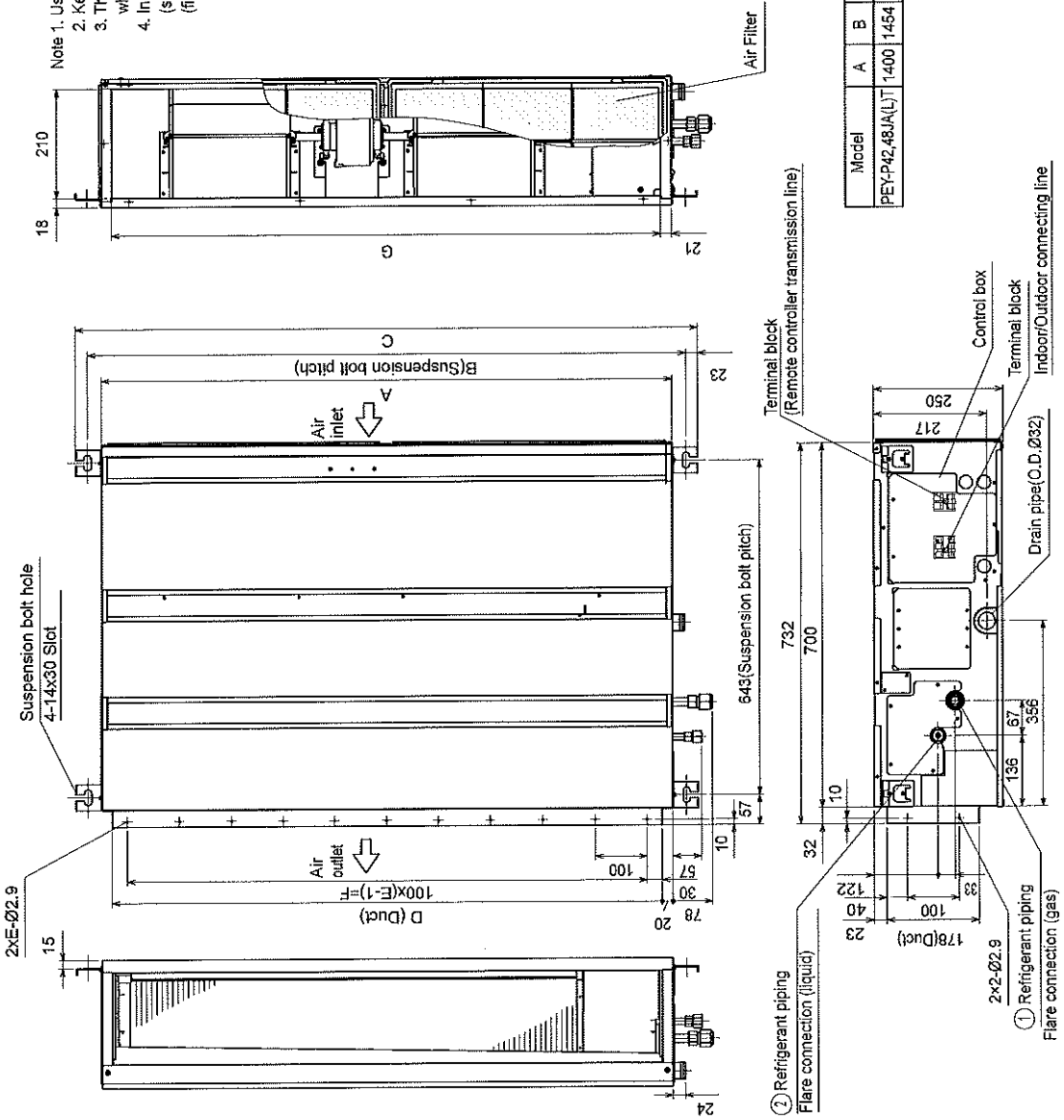

6

OUTLINES AND DIMENSIONS

SUY-KA18VA.TH
SUY-KA18VA.TH-U

Unit: mm

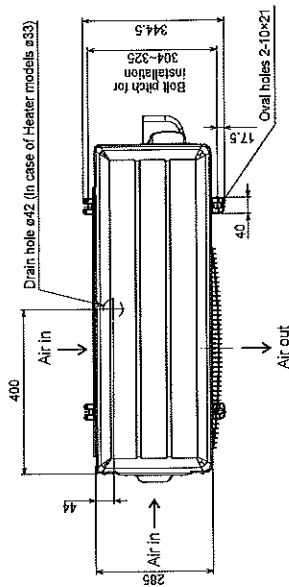
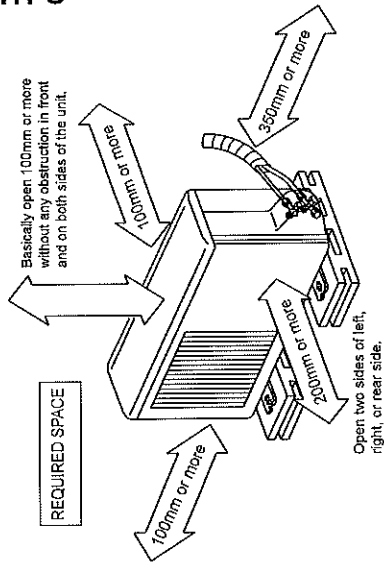

Model name	SUY-KA18VA
Refrigerant pipe joint	Flared 6.35(1/4")
Gas refrigerant pipe	Flared 12.7(1/2")

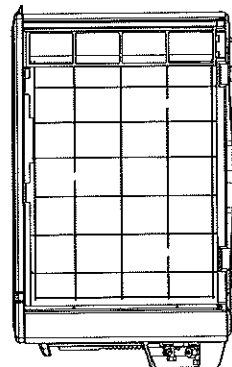
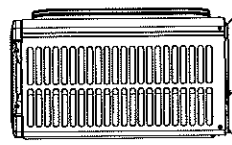
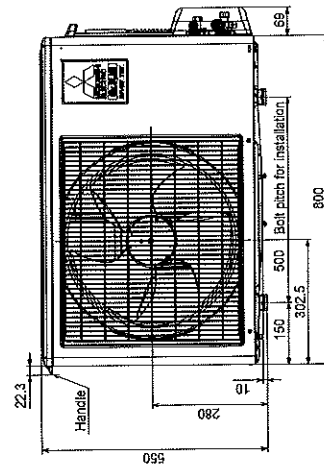
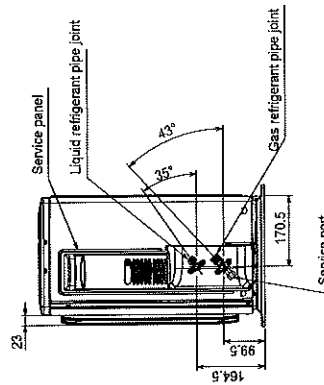

L-Band condenser models

PUY-P42VKA.TH
PUY-P42VKA.TH-T

PUY-P48VKA.TH
PUY-P48VKA.TH-T

PUY-P42YKA.TH
PUY-P42YKA.TH-T

PUY-P48YKA.TH
PUY-P48YKA.TH-T

Unit: mm

